

General Specifications

Model EJA510A and EJA530A Absolute and Gauge Pressure Transmitters

DPherp

GS 01C21F01-00E

[Style: S2]

The absolute and gauge pressure transmitter model EJA510A and EJA530A can be used to measure liquid, gas, or steam pressure. Both output a 4 to 20 mA DC signal corresponding to the measured pressure, and also feature remote setup and monitoring through communications with the BRAIN™ terminal and CENTUM CS™ or μXL™ or HART® 275 host.



■ STANDARD SPECIFICATIONS

Refer to GS 01C22T02-00E for FOUNDATION Fieldbus communication type and GS 01C22T03-00E for PROFIBUS PA communication type marked with “◇”.

□ PERFORMANCE SPECIFICATIONS

Zero-based calibrated span, linear output, wetted parts material code ‘S’ and silicone oil.

Reference Accuracy of Calibrated Span

(including the effects of zero-based linearity, hysteresis, and repeatability, values are in absolute for EJA510A)

±0.2 % of Span

±0.075 % of Span, when/ HAC is specified (EJA530A: A, B and C capsule)

±0.12 % of Span, when/ HAC is specified (EJA530A: D capsule)

For spans below X,

$\pm[0.05 + 0.15 \frac{X}{\text{Span}}]$ % of Span

$\pm[0.025 + 0.05 \frac{X}{\text{Span}}]$ % of span, when/ HAC is

specified (EJA530A: A, B and C capsule)

$\pm[0.03 + 0.09 \frac{X}{\text{Span}}]$ % of span, when/ HAC is

specified (EJA530A: D capsule)

Where X equals:

Capsule	X MPa {psi}
A	20 kPa {2.9}
A with/ HAC	40 kPa {5.8}
B	0.2 {29}
C	1 {145}
D	8 {1160}

Ambient Temperature Effects

Total Effects per 28 °C (50 °F) Change

±[0.15% Span + 0.15% URL]

Stability

±0.1% of URL per 12 months

Vibration Effects

±0.1 % of URL

(5 to 15Hz; 4mm peak-to-peak constant displacement, 15 to 150Hz; 2g, 150 to 2000Hz; 1g)

Power Supply Effects “◇”

±0.005 % per Volt (from 21.6 to 32 V DC, 350 Ω)

□ FUNCTIONAL SPECIFICATIONS

Span & Range Limits

(Values are in absolute for EJA510A)

Measurement Span and Range	MPa	psi (/D1)	bar (/D3)	kgf/cm ² (/D4)	
A	Span	10 to 200 kPa	1.45 to 29	0.1 to 2	0.1 to 2
	Range	0 to 200 kPa	0 to 29	0 to 2	0 to 2
B	Span	0.1 to 2	14.5 to 290	1 to 20	1 to 20
	Range	0 to 2	0 to 290	0 to 20	0 to 20
C	Span	0.5 to 10	72.5 to 1450	5 to 100	5 to 100
	Range	0 to 10	0 to 1450	0 to 100	0 to 100
D	Span	5 to 50	720 to 7200	50 to 500	50 to 500
	Range	0 to 50	0 to 7200	0 to 500	0 to 500

T01E.EPS

URL is defined as the Upper Range Limit from the table above.

Zero Adjustment Limits

Zero can be fully elevated or suppressed, within the Lower and Upper Range Limits of the capsule.

External Zero Adjustment “◇”

External zero is continuously adjustable with 0.01 % incremental resolution of span. Span may be adjusted locally using the digital indicator with range switch.

Mounting Position Effect

Rotation in diaphragm plane has no effect. Tilting up to 90° will cause zero shift up to 0.27 kPa {1.1 inH₂O} which can be corrected by the zero adjustment.

Output “◇”

Two wire 4 to 20 mA DC output with digital communications. BRAIN or HART FSK protocol are superimposed on the 4 to 20 mA signal.

Failure Alarm

Output status at CPU failure and hardware error;
 Up-scale: 110%, 21.6 mA DC or more (standard)
 Down-scale: -5%, 3.2 mA DC or less
 -2.5%, 3.6 mA DC or less (Optional code /F1)

Note : Applicable for Output signal code D and E.

Damping Time Constant (1st order)

The sum of the amplifier and capsule damping time constant must be used for the overall time constant. Amp damping time constant is adjustable from 0.2 to 64 seconds.

Capsule (Silicone Oil)	A, B, C, and D
Time Constant (approx. sec)	0.2

Ambient Temperature Limits

(approval codes may affect limits)

-40 to 85 °C (-40 to 185 °F)
 -30 to 80 °C (-22 to 176 °F) with LCD Display

Process Temperature Limits

(approval codes may affect limits)

-40 to 120 °C (-40 to 248 °F)

Ambient Humidity Limits

5 to 100 % RH @ 40 °C (104 °F)

Maximum Overpressure

Capsule	Capsule	
	EJA510A	EJA530A
A	4 MPa abs{580 psia}	4 MPa {580 psig}
B	4 MPa abs{580 psia}	4 MPa {580 psig}
C	20 MPa abs{2900 psia}	20 MPa {2900 psig}
D	60 MPa abs{8500 psia}	60 MPa {8500 psig}

Working Pressure Limits (Silicone Oil)

Maximum Pressure Limit

Capsule	Capsule	
	EJA510A	EJA530A
A	200 kPa abs{29 psia}	200 kPa {29 psig}
B	2 MPa abs{290 psia}	2 MPa {290 psig}
C	10 MPa abs{1450 psia}	10 MPa {1450 psig}
D	50 MPa abs{7200 psia}	50 MPa {7200 psig}

Minimum Pressure Limit

See graph below.

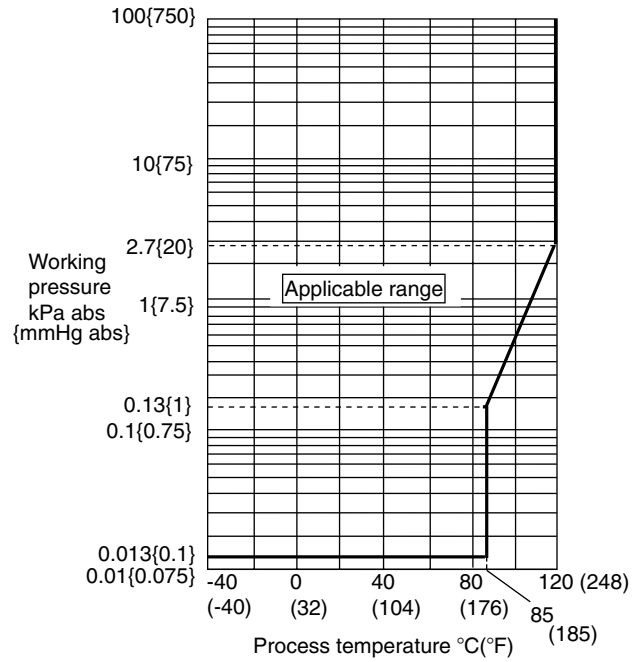

F01E.EPS

Figure 1. Working Pressure and Process Temperature [For model EJA510A]

Supply & Load Requirements

(Safety approvals can affect electrical requirements, see graph below)

With 24 V DC supply, up to a 570 Ω load can be used.

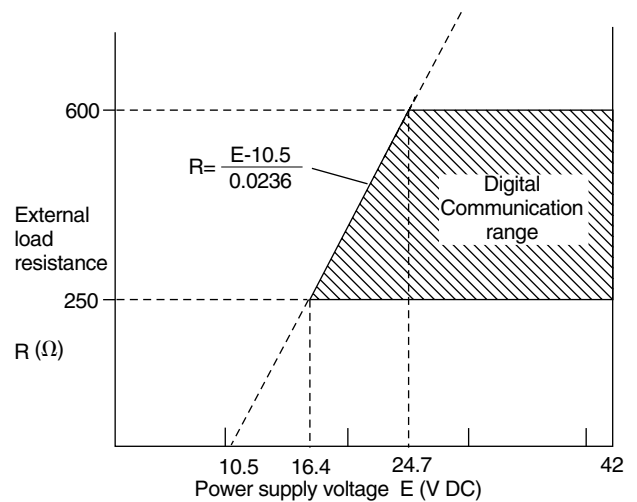

F02E.EPS

Figure 2. Relationship Between Power Supply Voltage and External Load Resistance

Supply Voltage “◇”

10.5 to 42 V DC for general use and flameproof type
 10.5 to 32 V DC for lightning protector (Optional code /A)
 10.5 to 30 V DC for intrinsically safe, Type n, nonincendive, or non-sparking type
 Minimum voltage limited at 16.4 V DC for digital communications, BRAIN and HART

Load (Output signal code D and E)

0 to 1335 Ω for operation
 250 to 600 Ω for digital communication

EMC Conformity Standards “◇” CE , N200

EN61326-1 Class A, Table2 (For use in industrial locations)
 EN61326-2-3

European Pressure Equipment Directive 97/23/EC

Sound Engineering Practice

With option code /PE3

CE₀₀₃₈
 Category III, Module H, Type of Equipment: Pressure Accessory-Vessel, Type of Fluid: Liquid and Gas, Group of Fluid: 1 and 2

Safety Requirement Standards

EN61010-1
 • Altitude of installation site: Max. 2,000 m above sea level
 • Installation category: I
 • Pollution degree: 2
 • Indoor/Outdoor use

Communication Requirements “◇”

BRAIN

Communication Distance

Up to 2 km (1.25 miles) when using CEV polyethylene-insulated PVC-sheathed cables. Communication distance varies depending on type of cable used.

Load Capacitance

0.22 μF or less (see note)

Load Inductance

3.3 mH or less (see note)

Spacing from power line

15 cm or more.

Input Impedance of communicating device

10 kΩ or more at 2.4 kHz.

Note : For general-use and Flameproof type.
 For Intrinsically safe type, please refer to 'OPTIONAL SPECIFICATIONS.'

□ **PHYSICAL SPECIFICATIONS**

Wetted Parts Materials:

Diaphragm and Process connector
 Refer to 'MODEL AND SUFFIX CODE.'

Non-wetted Parts Materials:

Housing
 Low copper cast-aluminum alloy with polyurethane paint (Munsell 0.6GY3.1/2.0)

Degrees of Protection
 IP67, NEMA4X

Cover O-rings
 Buna-N, fluoro-rubber (optional)

Data plate and tag
 SUS304 or SUS316 (option)

Fill Fluid
 Silicone, Fluorinated oil (option)

Weight
 1.6 kg (3.5 lb) without integral indicator, mounting bracket.

Connections
 Refer to the model code to specify the process and the electrical connection type.

< **Settings When Shipped** > “◇”

Tag Number	As specified in order *1
Output Mode	'Linear'
Display Mode	'Linear'
Operation Mode	'Normal' unless otherwise specified in order
Damping Time Constant	'2 sec.'
Calibration Range Lower Range Value	As specified in order
Calibration Range Higher Range Value	As specified in order
Calibration Range Units	Selected from mmH ₂ O, mmAq, mmWG, mmHg, Torr, Pa, hPa, kPa, MPa, mbar, bar, gf/cm ² , kgf/cm ² , inH ₂ O, inHg, ftH ₂ O, psi, or atm.(Only one unit can be specified)

T05E.EPS

*1: Up to 16 alphanumeric characters for BRAIN and 8 characters for HART including '-' and '.' will be entered in the amplifier memory. If specified Tag includes other characters than above, it will not be entered in the amplifier memory.

MODEL AND SUFFIX CODES

Model EJA510A and EJA530A

Model	Suffix Codes	Description
EJA510A EJA530A	Absolute pressure transmitter Gauge pressure transmitter
Output Signal	-D -E -F -G	4 to 20 mA DC with digital communication (BRAIN protocol) 4 to 20 mA DC with digital communication (HART protocol, refer to GS 01C22T01-00E) Digital communication (FOUNDATION Fieldbus protocol, refer to GS 01C22T02-00E) Digital communication (PROFIBUS PA protocol, refer to GS 01C22T03-00E)
Measurement span (capsule)	A B C D	10 to 200 kPa {0.1 to 2 kgf/cm ² } {1.45 to 29 psi} {0.1 to 2 bar} 0.1 to 2 MPa {1 to 20 kgf/cm ² } {14.5 to 290 psi} {1 to 20 bar} 0.5 to 10 MPa {5 to 100 kgf/cm ² } {72.5 to 1450 psi} {5 to 100 bar} 5 to 50 MPa {50 to 500 kgf/cm ² } {720 to 7200 psi} {50 to 500 bar}
Wetted parts material *2	S# H#	[Process Connection] [Diaphragm] SUS316L *4 Hastelloy C-276 *3 Hastelloy C-276 *3 Hastelloy C-276 *3
Process connection	4 7 8 9	1/2 NPT female 1/2 NPT male G 1/2 DIN 16 288 male M20×1.5 DIN 16 288 male
—	N	Always N
—	-0	Always 0
Electrical connection	0 2 3 4 5 7 8 9 A C D	G1/2 female, one electrical connection 1/2 NPT female, two electrical connections without blind plug Pg 13.5 female, two electrical connections without blind plug M20 female, two electrical connections without blind plug G1/2 female, two electrical connections and a blind plug 1/2 NPT female, two electrical connections and a blind plug Pg 13.5 female, two electrical connections and a blind plug M20 female, two electrical connections and a blind plug G1/2 female, two electrical connections and a SUS316 blind plug 1/2 NPT female, two electrical connections and a SUS316 blind plug M20 female, two electrical connections and a SUS316 blind plug
Integral indicator	D ... E ... N ...	Digital indicator Digital indicator with the range setting switch *1 (None)
Mounting bracket	E .. F .. L .. N ..	SECC Carbon steel 2-inch pipe mounting SUS304 2-inch pipe mounting SUS316 2-inch pipe mounting (None)
Optional codes		<input type="checkbox"/> Optional specification

T02E.EPS

The '☆' marks indicate the most typical selection for each specification. Example: EJA530A-DAS4N-02NN/□

The '#' marks indicate the construction materials conform to NACE material recommendations per MR01-75. For the use of SUS316 material, there may be certain limitations for pressure and temperature. Please refer to NACE standards for details.

*1: Not applicable for Output signal code F and G.

*2:  Users must consider the characteristics of selected wetted parts material and the influence of process fluids. The use of inappropriate materials can result in the leakage of corrosive process fluids and cause injury to personnel and/or damage to plant facilities. It is also possible that the diaphragm itself can be damaged and that material from the broken diaphragm and the fill fluid can contaminate the user's process fluids.

Be very careful with highly corrosive process fluids such as hydrochloric acid, sulfuric acid, hydrogen sulfide, sodium hypochlorite, and high-temperature steam (150°C [302°F] or above). Contact Yokogawa for detailed information of the wetted parts material.

*3: Hastelloy C-276 or ASTM N10276.

*4: SUS316L or ASTM grade 316L.

OPTIONAL SPECIFICATIONS (For Explosion Protected types “◇”)

For FOUNDATION Fieldbus explosion protected type, see GS 01C22T02-00E.

For PROFIBUS PA explosion protected type, see GS 01C22T03-00E.

Item	Description	Code
Factory Mutual (FM)	FM Explosionproof Approval *1 *3 *4 Applicable standard: FM3600, FM3615, FM3810, ANSI/NEMA250 Explosionproof for Class I, Division 1, Groups B, C and D Dust-ignitionproof for Class II/III, Division 1, Groups E, F and G Hazardous (classified) locations, indoors and outdoors (NEMA 4X) Temperature class: T6 Amb. Temp.: -40 to 60°C (-40 to 140°F)	FF1
	FM Intrinsically safe Approval *1 *3 *4 Applicable standard: FM3600, FM3610, FM3611, FM3810, ANSI/NEMA250 Intrinsically Safe for Class I, Division 1, Groups A, B, C & D, Class II, Division 1, Groups E, F & G and Class III, Division 1 Hazardous Locations. Nonincendive for Class I, Division 2, Groups A, B, C & D, Class II, Division. 2, Groups E, F & G, and Class III, Division 1 Hazardous Locations. Enclosure: “NEMA 4X”, Temp. Class: T4, Amb. Temp.: -40 to 60°C (-40 to 140°F) Intrinsically Safe Apparatus Parameters [Groups A, B, C, D, E, F and G] Vmax=30 V, Imax=165 mA, Pmax=0.9 W, Ci=22.5 nF, Li=730 μH [Groups C, D, E, F and G] Vmax=30 V, Imax=225 mA, Pmax=0.9 W, Ci=22.5 nF, Li=730 μH	FS1
	Combined FF1 and FS1 *1 *3 *4	FU1
ATEX	ATEX Flameproof Approval *2 *4 Applicable standard: EN 60079-0, EN 60079-1 Certificate: KEMA 02ATEX2148 II 2G Ex d IIC T4, T5, T6 Amb. Temp.: T5; -40 to 80°C (-40 to 176°F), T4 and T6; -40 to 75°C (-40 to 167°F) Max. process Temp.: T4; 120°C (248°F), T5; 100°C (212°F), T6; 85°C (185°F)	KF21
	ATEX Intrinsically safe Approval *2 *3 *4 Applicable standard: EN50014, EN50020, EN50284 Certificate: KEMA 02ATEX1030X II 1G EEx ia IIC T4, Amb. Temp.: -40 to 60°C (-40 to 140°F) Ui=30 V, li=165 mA, Pi=0.9 W, Ci=22.5 nF, Li=730 μH	KS2

T03-1E.EPS

- *1: Applicable for Electrical connection code 2, 7 and C (1/2 NPT female).
- *2: Applicable for Electrical connection code 2, 4, 7, 9, C and D (1/2 NPT and M20 female).
- *3: Applicable for Output signal code D and E.
- For intrinsically safe approval, use the safety barrier certified by the testing laboratories (BARD-400 is not applicable).
- *4: Lower limit of ambient temperature is -15°C (5°F) when /HE is specified.

Item	Description	Code
Canadian Standards Association (CSA)	CSA Explosionproof Approval *1 *3 *4 Applicable standard: C22.2 No. 0, No. 0.4, No. 25, No. 30, No. 94, No. 142 Certificate: 1089598 Explosionproof for Class I, Division 1, Groups B, C and D Dustignitionproof for Class II/III, Division 1, Groups E, F and G Division2 'SEALS NOT REQUIRED' , Temp. Class: T4, T5, T6 Encl Type 4x Max. Process Temp.: T4; 120°C (248°F), T5; 100°C (212°F), T6; 85°C (185°F) Amb. Temp.: -40 to 80°C (-40 to 176°F) Process Sealing Certification Dual Seal Certified by CSA to the requirement of ANSI/ISA 12.27.01 No additional sealing required. Primary seal failure annunciation: at the zero adjustment screw	CF1
	CSA Intrinsically safe Approval *1 *3 *4 Applicable standard: C22.2 No. 0, No. 0.4, No. 25, No. 30, No. 94, No. 142, No. 157, No. 213 Certificate: 1053843 Class I, Groups A, B, C and D Class II and III, Groups E, F and G Encl Type 4x, Temp. Class: T4, Amb. Temp.: -40 to 60°C (-40 to 140°F) Vmax=30 V, Imax=165 mA, Pmax=0.9 W, Ci=22.5 nF, Li=730 μH Process Sealing Certification Dual Seal Certified by CSA to the requirement of ANSI/ISA 12.27.01 No additional sealing required. Primary seal failure annunciation: at the zero adjustment screw	CS1
	Combined CF1 and CS1 *1 *3 *4	CU1
IECEX Scheme	IECEx Intrinsically safe, type n and Flameproof Approval *3 *4 *5 Intrinsically safe and type n Applicable Standard: IEC 60079-0:2004, IEC 60079-11:1999, IEC 60079-15:2005, IEC 60079-26:2005 Certificate: IECEx KEM 06.0007X Ex ia IIC T4, Ex nL IIC T4 Enclosure: IP67 Amb. Temp.: -40 to 60°C (-40 to 140°F), Max. Process Temp.: 120°C (248°F) Electrical Parameters: [Ex ia] Ui=30 V, li=165 mA, Pi=0.9 W, Ci=22.5 nF, Li=730 μH [Ex nL] Ui=30 V, Ci=22.5 nF, Li=730 μH Flameproof Applicable Standard: IEC 60079-0:2004, IEC60079-1:2003 Certificate: IECEx KEM 06.0005 Ex d IIC T6...T4 Enclosure: IP67 Max.Process Temp.: T4;120°C (248°F), T5;100°C (212°F), T6; 85°C (185°F) Amb.Temp.: -40 to 75°C (-40 to 167°F) for T4, -40 to 80°C (-40 to 176°F) for T5, -40 to 75°C (-40 to 167°F) for T6	SU2

T03-2E.EPS

- *1: Applicable for Electrical connection code 2, 7 and C (1/2 NPT female).
- *2: Applicable for Electrical connection code 2, 4, 7, 9, C and D (1/2 NPT and M20 female).
- *3: Applicable for Output signal code D and E.
For intrinsically safe approval, use the safety barrier certified by the testing laboratories (BARD-400 is not applicable).
- *4: Lower limit of ambient temperature is -15°C (5°F) when /HE is specified.
- *5: Applicable for Electrical connection code 2, 4, 7, C and D (1/2 NPT and M20 female).

OPTIONAL SPECIFICATIONS

Item	Description		Code
High accuracy type *11	High accuracy		HAC
Painting *12	Color change	Amplifier cover only	P□
		Amplifier cover and terminal cover, Munsell 7.5 R4/14	PR
	Coating change	Epoxy resin-baked coating *15	X1
Fluoro-rubber O-ring	All O-rings of amplifier housing. Lower limit of ambient temperature: -15°C (5°F)		HE
Lightning protector	Transmitter power supply voltage: 10.5 to 32 V DC (10.5 to 30 V DC for intrinsically safe type, 9 to 32 V DC for Fieldbus communication type.) Allowable current: Max. 6000 A (1×40 μs), Repeating 1000 A (1×40 μs) 100 times		A
Oil-prohibited use	Degrease cleansing treatment *15		K1
	Degrease cleansing treatment with fluorinated oil filled capsule. Operating temperature -20 to 80°C		K2
Calibration units *1	P calibration (psi unit)	(See Table for Span and Range Limits.)	D1
	bar calibration (bar unit)		D3
	M calibration (kgf/cm ² unit)		D4
Fast response *9	Update time: 0.125 sec Amplifier damping time constant: 0.1 to 64 sec in 9 increments Response time (with min. damping time constant): max. 0.3 sec		F1
Failure alarm down-scale *2	Output status at CPU failure and hardware error is -5%, 3.2 mA or less.		C1
NAMUR NE43 compliant *2 *10	Output signal limits: 3.8 mA to 20.5 mA	Failure alarm down-scale: output status at CPU failure and hardware error is -5%, 3.2 mA or less.	C2
		Failure alarm up-scale: output status at CPU failure and hardware error is 110%, 21.6 mA or more.	C3
Data configuration at factory *16	Description into "Descriptor" parameter of HART protocol		CA
Stainless steel amplifier housing *3	Amplifier housing material; SCS14A stainless steel (equivalent to SUS316 cast stainless steel or ASTM CF-8M)		E1
Wired tag plate	Stainless steel tag plate wired onto transmitter		N4
European Pressure Equipment Directive *14	PED 97/23/EC Category: III, Module: H, Type of Equipment: Pressure Accessory-Vessel, Type of Fluid: Liquid and Gas, Group of Fluid: 1 and 2		PE3
Mill Certificate	Process connector		M15
Pressure test/Leak test Certificate *13	Test Pressure: 200 kPa (2 kgf/cm ²) *4	Nitrogen (N ₂) Gas or Water *8 Retention time: 10 minutes	T05
	Test Pressure: 2 MPa (20 kgf/cm ²) *5		T06
	Test Pressure: 10 MPa (100 kgf/cm ²) *6		T07
	Test Pressure: 50 MPa (500 kgf/cm ²) *7		T08

T04E.EPS

- *1: The unit of MWP (Max. working pressure) on the name plate of a housing is the same unit as specified by Option code D1, D3 and D4.
- *2: Applicable for Output signal code D and E. The hardware error indicates faulty amplifier or capsule. When combining with Option code F1, output status for down-scale is -2.5%, 3.6 mA DC or less.
- *3: Applicable for Electrical connection code 2, 3, 4, A, C and D. Not applicable for Option code P□ and X1.
- *4: Applicable for Capsule code A.
- *5: Applicable for Capsule code B.
- *6: Applicable for Capsule code C.
- *7: Applicable for Capsule code D.
- *8: Pure nitrogen gas or pure water is used for oil-prohibited use (Option code K1 and K2)
- *9: Applicable for Output signal code D and E. Write protection switch is attached for Output code E.
- *10: Not applicable for Option code C1.
- *11: Applicable for EJA530A. Refer to GS 01C21F01-02E.
- *12: Standard polyurethan painting can be used in acid atmosphere, whereas the epoxy resin-baked coating (Option code X1) can be used in alkaline atmosphere. Anti-corrosion coating, the combination of polyurethan and epoxy resin-baked coating, is available by special order as sea water, alkaline, and acid resistant.
- *13: The unit on the certificate is always kPa or MPa regardless of selection of option code D1, D3, or D4.
- *14: If compliance with category III is needed, specify this option code.
- *15: Not applicable for color change option.
- *16: Applicable for Output signal code E.

DIMENSIONS

Model EJA510A and EJA530A

◆ With Process Connection code 7

Unit: mm(Approx. inch)

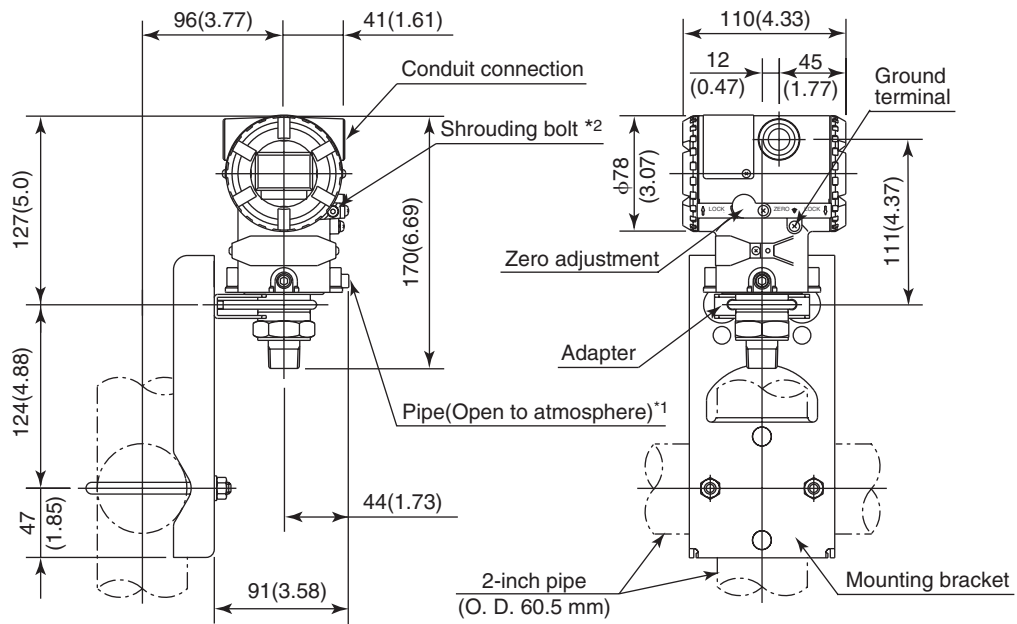

*1: Applied to Model EJA530A with Measurement span code A, B, and C.
 *2: Applicable only for ATEX and IECEx Flameproof type.

◆ For Process Connection code 4

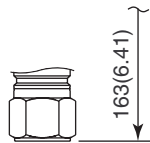

◆ For Process Connection code 8 and 9

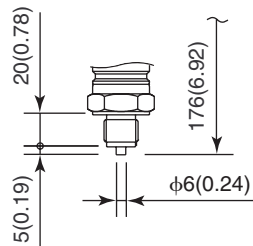

F03E.EPS

Terminal Configuration

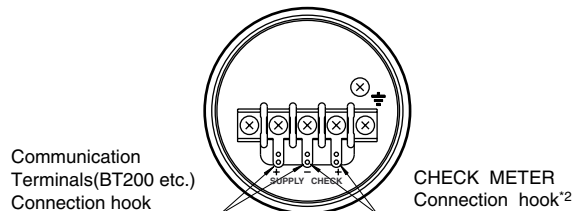

Terminal Wiring

SUPPLY $\begin{matrix} + \\ - \end{matrix}$	Power supply and output terminal
CHECK $\begin{matrix} + \\ - \end{matrix}$	External indicator(ammeter) terminal ^{*2}
---	Ground terminal

*2: When using an external indicator or a check meter, the internal resistance must be 10 Ω or less. Not available for Fieldbus communication (Output signal code F and G).

F04E.EPS

SELECTION GUIDE

Application	Type	Model	Capsule	Measurement Span		Maximum Working Pressure	
				kPa	inH ₂ O	MPa	psi
Differential Pressure	Traditional-Mounting ^{*1}	EJA110A	L	0.5 to 10	2 to 40	16 ^{*4}	2250 ^{*4}
			M	1 to 100	4 to 400	16	2250
			H	5 to 500	20 to 2000	16	2250
			V	0.14 to 14MPa	20 to 2000 psi	16	2250
Flow	Integral Orifice	EJA115	L	1 to 10	4 to 40	3.5	500
			M	2 to 100	8 to 400	14	2000
			H	20 to 210	80 to 830	14	2000
Differential Pressure & Liquid Level with Remote Seals	Extended Flush Combination	EJA118N EJA118W EJA118Y	M	2.5 to 100	10 to 400	Based on Flange Rating	
			H	25 to 500	100 to 2000		
Draft Range	Traditional-Mounting ^{*1}	EJA120A	E	0.1 to 1	0.4 to 4	50 kPa	7.25
Differential Pressure & Liquid Level	Traditional-Mounting ^{*1}	EJA130A	M	1 to 100	4 to 400	32	4500
			H	5 to 500	20 to 2000	32	4500
Liquid Level, Closed or Open Tank	Flush Extended	EJA210A EJA220A	M	1 to 100	4 to 400	Based on Flange Rating	
			H	5 to 500	20 to 2000		
Absolute (vacuum) Pressure	Traditional-Mounting ^{*1}	EJA310A	L	0.67 to 10 ^{*2}	2.67 to 40 ^{*2}	10 kPa ^{*2}	40 in H ₂ O ^{*2}
			M	1.3 to 130 ^{*2}	0.38 to 38 inHg ^{*2}	130 kPa ^{*2}	18.65 ^{*2}
			A	0.03 to 3 MPa ^{*2}	4.3 to 430 psi ^{*2}	3000 kPa ^{*2}	430 ^{*2}
Gauge Pressure	Traditional-Mounting ^{*1}	EJA430A	A	0.03 to 3 MPa	4.3 to 430 psi	3	430
			B	0.14 to 14 MPa	20 to 2000 psi	14	2000
Gauge Pressure with Remote Seal	Extended	EJA438N	A	0.06 to 3 MPa	8.6 to 430 psi	Based on Flange Rating	
B	0.46 to 7 MPa	66 to 1000 psi					
Gauge Pressure with Remote Seal	Flush	EJA438W	A	0.06 to 3 MPa	8.6 to 430 psi	Based on Flange Rating	
B	0.46 to 14 MPa	66 to 2000 psi					
High Gauge	Traditional-Mounting ^{*1}	EJA440A	C	5 to 32 MPa	720 to 4500 psi	32	4500
			D	5 to 50 MPa	720 to 7200 psi	50	7200
Absolute & Gauge Pressure ^{*3}	Direct-Mounting	EJA510A EJA530A	A	10 to 200	1.45 to 29 psi	200 kPa	29
			B	0.1 to 2 MPa	14.5 to 290 psi	2	290
			C	0.5 to 10 MPa	72.5 to 1450 psi	10	1450
			D	5 to 50 MPa	720 to 7200 psi	50	7200

T06E.EPS

- *1: Traditional-mounting is 1/4 - 18 NPTF process connections (1/2 - 14 NPTF with process adapters) on 2-1/8" centers.
- *2: Measurement values in absolute.
- *3: Measurement values in absolute for EJA510A.
- *4: When combined with Wetted parts material code H, M, T, A, D, and B, the value is 3.5 MPa (500 psi).

< Ordering Information > “◇”

Specify the following when ordering

1. Model, suffix codes, and optional codes
2. Calibration range and units:
 - 1) Calibration range can be specified with range value specifications up to 5 digits (excluding any decimal point) for low or high range limits within the range of -32000 to 32000.
 - 2) Specify only one unit from the table, 'Settings when shipped.'
3. Select linear or square root for output mode and display mode.

Note: If not specified, the instrument is shipped set for linear mode.
4. Select normal or reverse for operation mode

Note: If not specified, the instrument is shipped in normal operation mode.
5. Display scale and units (for transmitters equipped with integral indicator only)

Specify either 0 to 100 % or engineering unit scale and 'Range and Unit' for engineering units scale: Scale range can be specified with range limit specifications up to 5 digits (excluding any decimal point) for low or high range limits within the range of -19999 to 19999.
6. Tag Number (if required)

< Related Instruments > “◇”

Power Distributor: Refer to GS 01B04T01-02E or GS 01B04T02-02E
BRAIN TERMINAL: Refer to GS 01C00A11-00E

< Reference >

1. Teflon; Trademark of E.I. DuPont de Nemours & Co.
2. Hastelloy; Trademark of Haynes International Inc.
3. HART; Trademark of the HART Communication Foundation.
4. FOUNDATION ; Trademark of Fieldbus Foundation.
5. PROFIBUS; Registered trademark of Profibus Nutzerorganisation e.v., Karlsruhe, Germany.

Material Cross Reference Table

SUS316L	AISI 316L
SUS316	AISI 316
SUS304	AISI 304
S25C	AISI 1025
SCM435	AISI 4137
SUS630	ASTM630
SCS14A	ASTM CF-8M

T07E.EPS

6. Other company names and product names used in this material are registered trademarks or trademarks of their respective owners.

< Specification Conformance >

The model EJA510A and EJA530A maintain a specification conformance to at least 3 σ .